

PRODUCT CATALOGUE

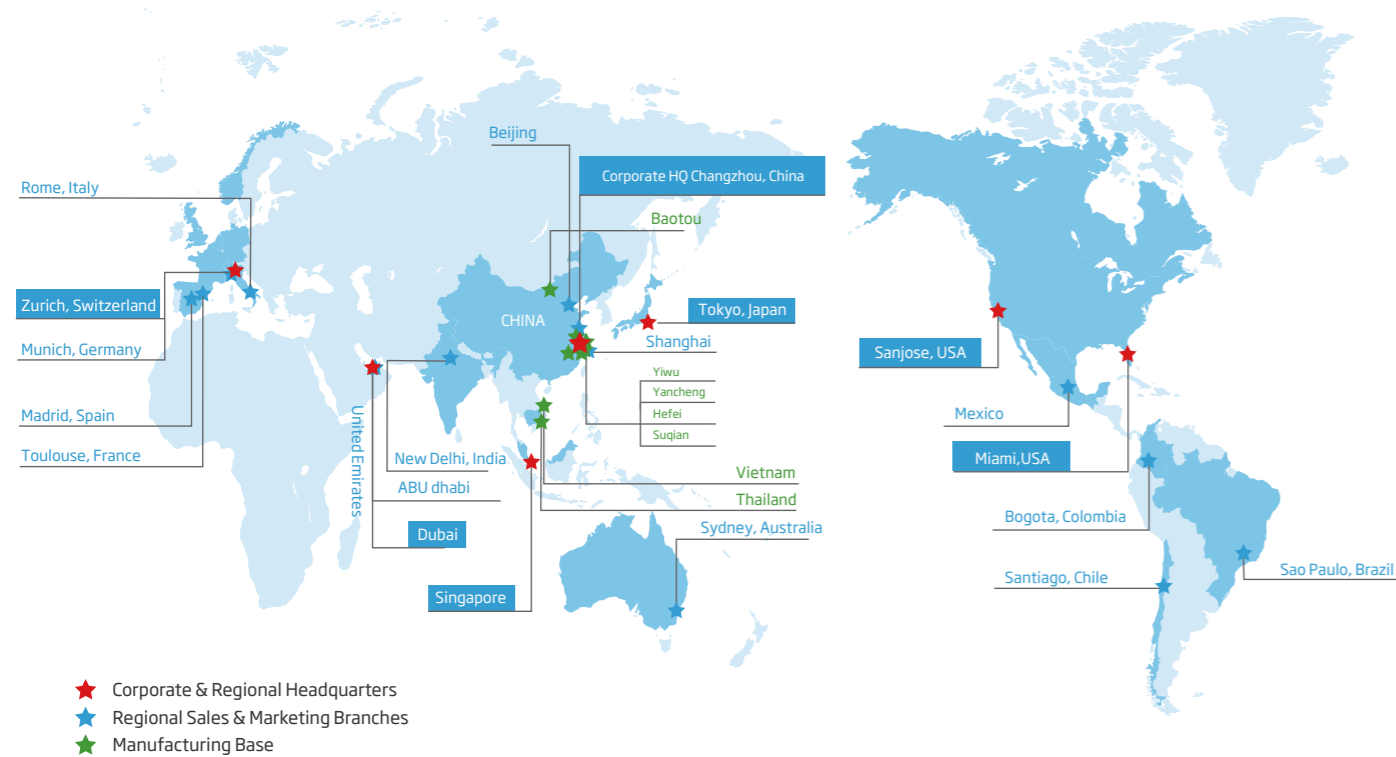

WORLD'S LEADING SOLAR COMPANY

Founded in 1997, Trina Solar has established a global network covering production, sales and service. The company processes upstream and downstream businesses across more than 100 countries and regions worldwide with 40 branches, and has overseas employees from over 30 countries and regions.



As of Q1 2020, the cumulative total module shipments of the company has reached 50GW, leading the industry. Based on the annual report of IHS, Trina Solar has been ranked among Top 3 in terms of global module shipment for the year of 2017, 2018 and 2019. Further, Trina Solar has been rated as a Tier 1 firm by Bloomberg, IHS and others for consecutive years. With its strong financials, Trina Solar is in leading the industry. In 2018, its asset-liability ratio was approximately 58%, and its sales revenue crossed 25 billion yuan.



FULLY BANKABLE

A commitment to excellence in all aspects of the organization, a strong corporation with a solid balance sheet, and proven product quality and reliability are some of the key attributes of a bankable brand.

In 2019, Trina solar has been rated as fully bankable by 100% of the experts participating in the BNEF's bankability research. This is the fourth time in a row that the company has been recognized by BNEF.



GROUND-BREAKING INNOVATIONS

For the past two decades, Trina Solar has been at the forefront in solar innovation. Trina Solar owns two national-level innovation platforms, the State Key Laboratory of PV Science and Technology (SKL) and National Enterprise Technology Center, which gathers international top scientists from over ten countries. Till November 2019, Trina Solar's R&D team has broken 20 world records in the field of cell efficiency and module output power.



1720
patents applied



813
patents granted



A TOTAL OF 20 WORLD RECORDS IN PV CELL EFFICIENCY & MODULE OUTPUT

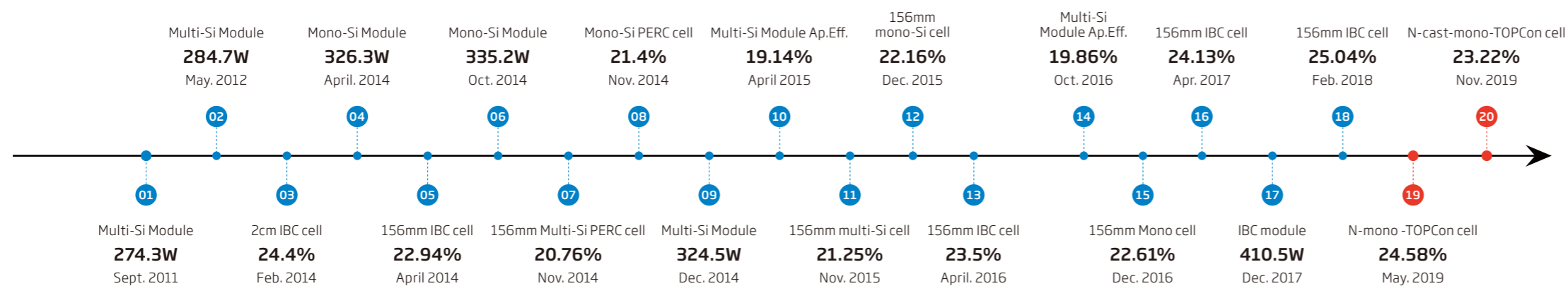

60
Over 60 government
funded projects

PRODUCTS YOU CAN RELY ON

Trina Solar's products have always maintained high reliability and solid performance based on our commitment to our quality first policy.

With over 200 in-house tests and a state of the art research and development lab, Trina Solar goes beyond requirements to deliver the highest quality products to customers. The company has been ranked as "Top performer" in the DNV.GL scorecard for 5 consecutive years. Winners of the award are selected on the basis of the annual PV Module Reliability Scorecard report released by PVEL and DNV GL.

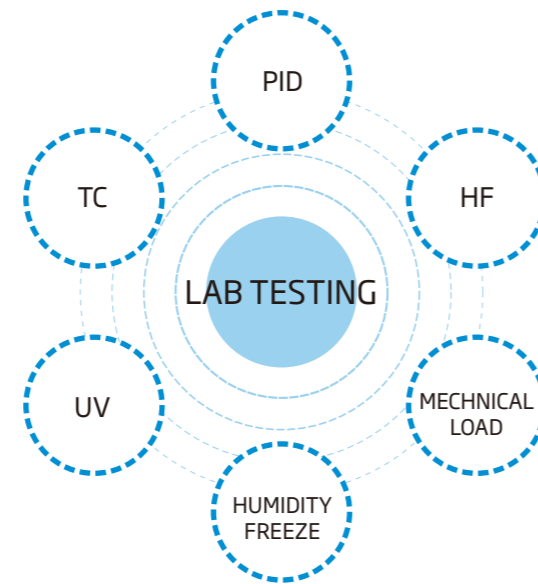

BIFACIAL PERC TECHNOLOGY

A typical PERC structure employs Al-BSF. Bifacial PERC is different from the typical PERC, with BSF replaced by Al grid, which can receive scattered solar radiation and thus achieve a bi-faciality of over 80%.

Trina Solar Duomax Twin modules adopt bifacial PERC as the core technology, in which Trina Solar has the most sophisticated R&D and industrialization capabilities. With the integration of dual-glass, multi-busbar and half-cut cell technologies, Duomax Twin can achieve higher energy generation performance.

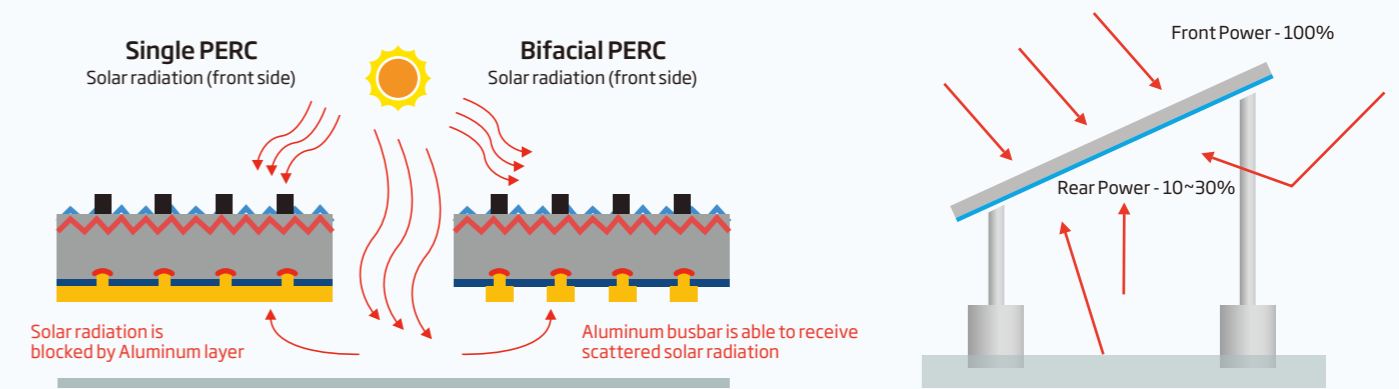

Reliability endorsed by third parties



- 
 High power generation
- 
 High reliability
- 
 Low LCOE
- 
 Wide application

DUAL-GLASS TECHNOLOGY

Dual-glass technology replaces the conventional glass-and-backsheet structure with a heat strengthened dual-glass structure. Trina Solar's technical team carried out in-depth R&D in dual-glass technology in 2012 and dual-glass modules were put into mass production in 2013. Thus, Trina Solar became one of the first companies manufacturing efficient dual-glass modules and bringing them to market. Until now, Trina Solar has shipped dual-glass modules with a total output of more than 3GW, more than any other manufacturer.

Trina Solar's next generation dual-glass modules incorporate half-cut cells and multi-busbar technology to enhance system reliability and power generation efficiency, while further reducing LCoE.

Highly reliable

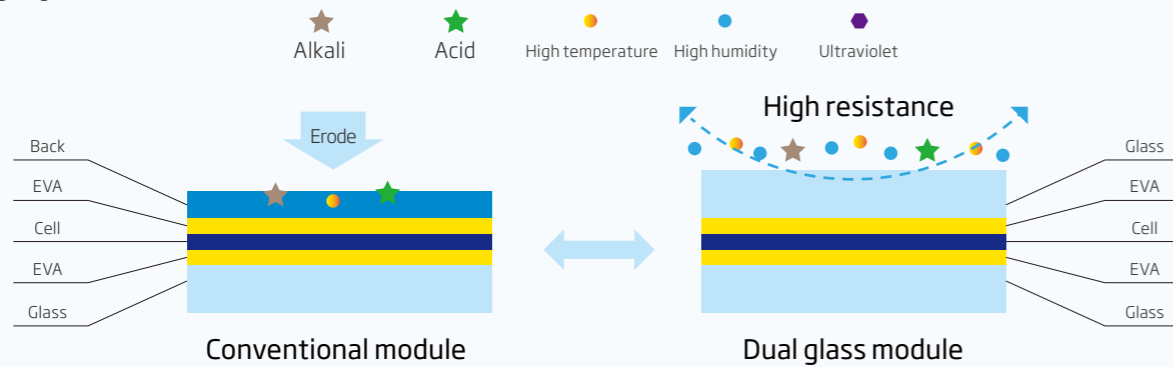

Lower degradation

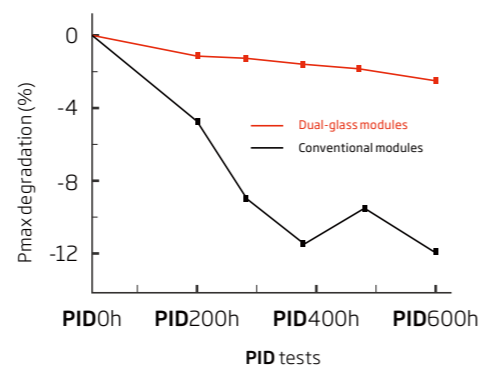
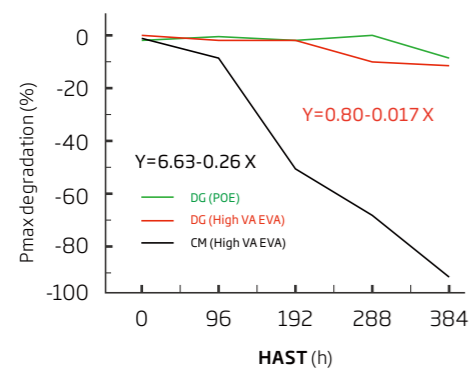

MULTI-BUSBAR TECHNOLOGY

Compared to the conventional five busbar soldering process, the multi-busbar (MBB) technology can increase output power of PV modules by 2% with finer and narrower busbars. As the pioneer of MBB technology, Trina Solar has always been taking the lead in R&D and mass production of MBB in the industry.

As early as 2015, Trina Solar started its research on MBB and joined hands with other players to develop the first-generation round welding strip and first-generation MBB cell series welding equipment in China. Moreover, Trina Solar was also among the first to solve technical difficulties in the process.

Increased light absorption

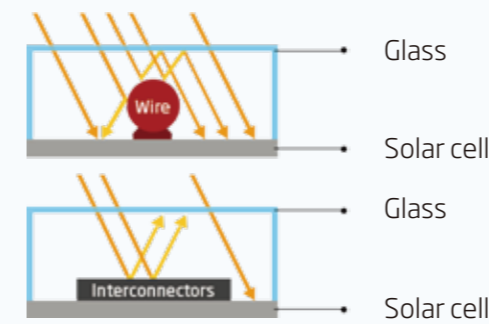

Rare chance of power loss due to micro-cracking



Reduced resistance losses with over 50% shortened current conduction distance

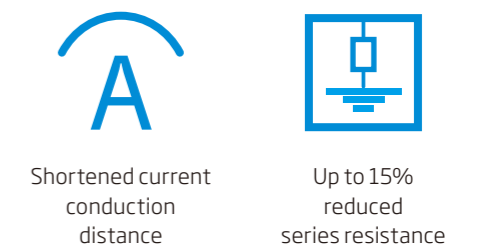
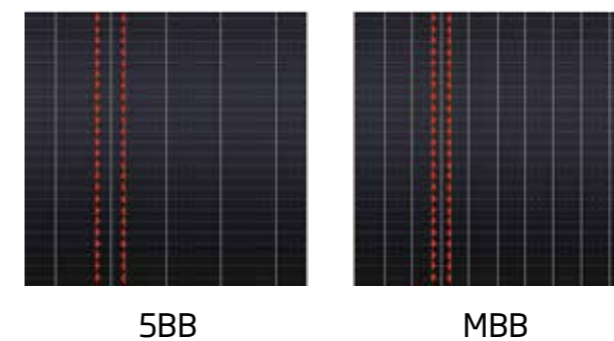

HALF-CUT AND NON-DESTRUCTIVE CUTTING(NDC) TECHNOLOGY

In half-cut technology, the full cell is cut into two parts, which results in a reduction of electrical ribbon resistance and finally improves the overall module efficiency by more than 2%. Also, half-cut design allows the module to work at low operating temperatures, which can improve energy generation per watt. And Trina Solar has adopted a non-destructive cutting technology based on the principle of thermal expansion and contraction.

Under the heat stress the wafer separates by itself. The cutting surface is very smooth without any micro-cracks. A NDC cell has a similar strength and mechanical robustness as a full cell and greatly surpasses that of the traditionally cut ones. Trina Solar has integrated half-cut and non-destructive technology into its new generation module product series, which significantly improves the actual power generation, especially when combined with other outstanding technologies like multi-busbar and bifacial cell design.

Better power generation with reduced internal resistance losses

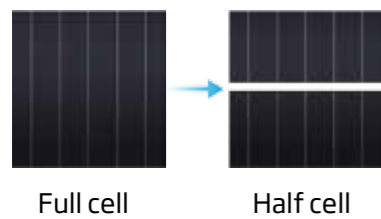

High reliability with strong resistance against hotspots

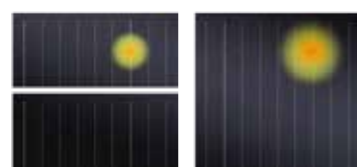

High power output with better shading tolerance

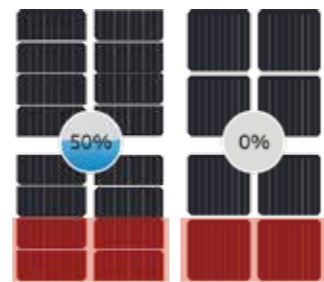

Traditional Cutting vs. NDC

Cutting process

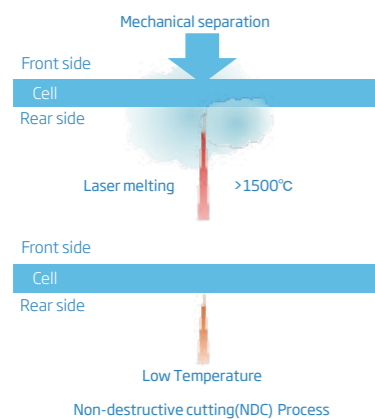

Cross section microscope picture of cutting edge

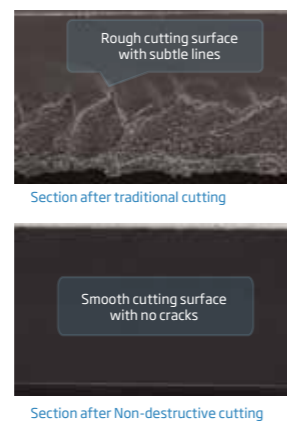

Comparison of mechanical properties

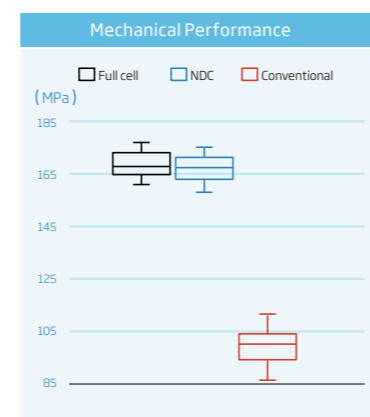

HIGH-DENSITY INTERCONNECTION TECHNOLOGY

The cell spacing of the traditional module is 2mm with the restriction of ribbon strength.

High-density interconnection technology is developed to further reduce the cell spacing to the minimum to optimize power output and efficiency.

Currently there are two different processes of cell encapsulation:

High-density interconnection:

By flattening cell connection areas of welding tape, the cell spacing is reduced to 0.5mm to achieve higher efficiency, which will leave a certain gap to reduce yield risk, micro-cracks and damage to the module.

Overlapping:

Cells are overlapped with overlapping area 0.2-0.5mm through connections of welding tapes, which could achieve an even higher efficiency than the first process. However, the cell breakage rate will increase during production and module deformation will appear, which will result in micro-cracks.

Trina Solar Vertex modules employ the high-density interconnection to achieve over 21% ultra-high efficiency.

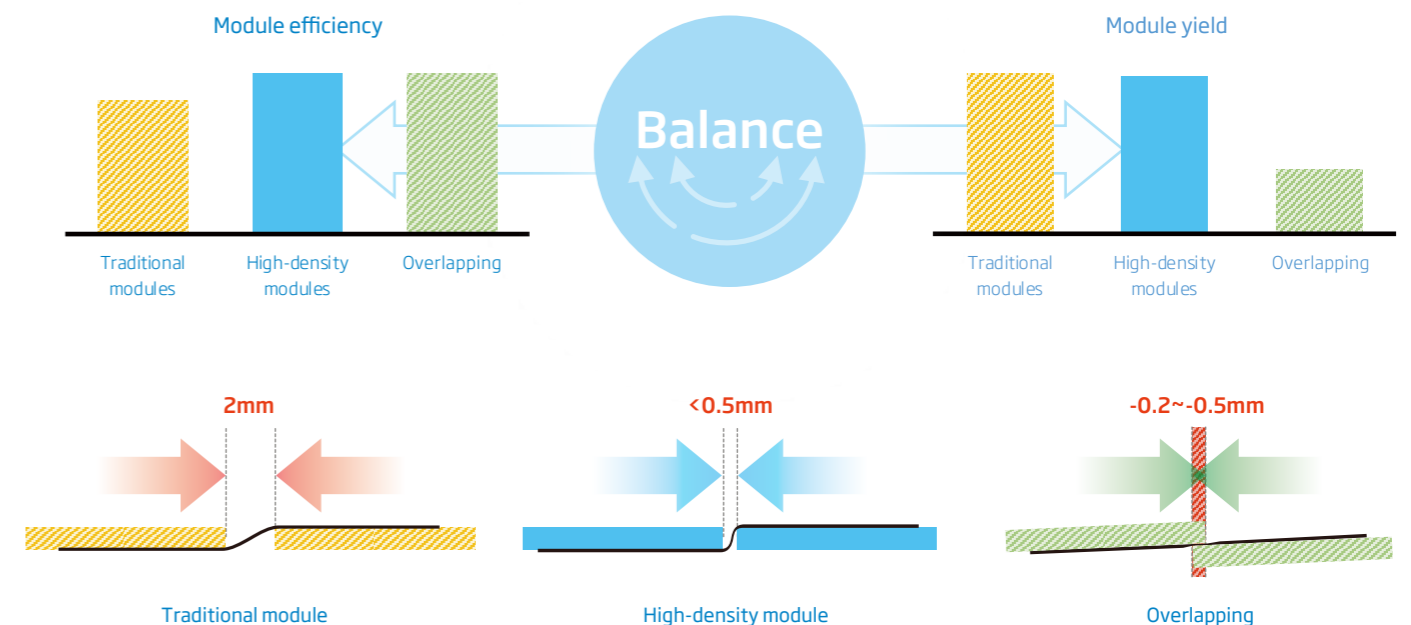

PRODUCT PORTFOLIO

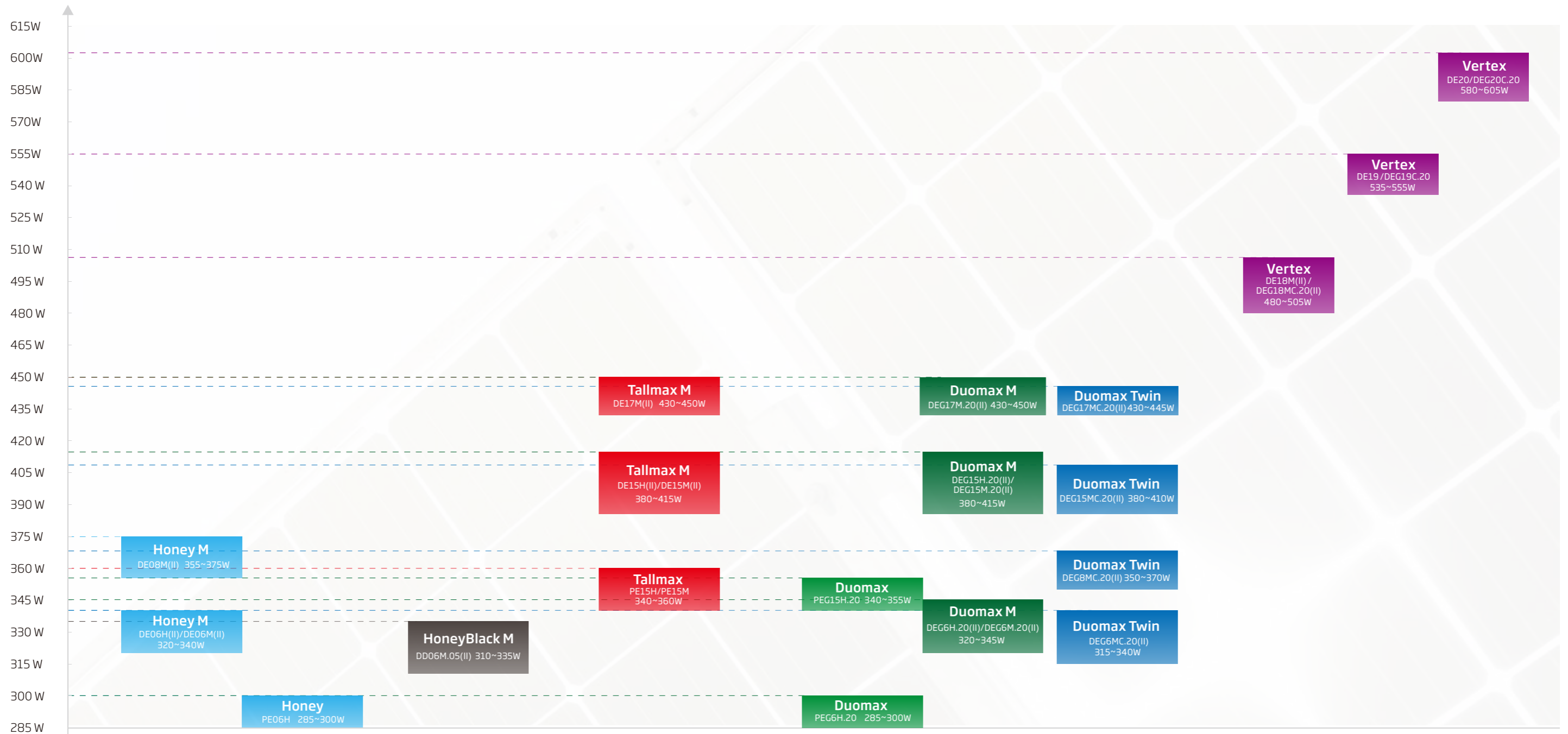

Product Series



Honey

Designed for residential and commercial installation

HoneyBlack^M

Designed for high-end residential installation

TALLMAX

Designed for commercial buildings and utility-scale projects

DUOMAX

Designed for harsh environments, such as deserts, saline-alkali and tropical beaches

DUOMAX^{twin}

Designed for utility projects, especially for highly reflective environments

Vertex

Designed for utility and C&I projects

THE VERTEX SERIES



Designed for utility and C&I projects



Trina Solar Vertex series modules, with a module conversion efficiency over 21%, boast a power output up to 600 W. Incorporating 210mm cells, the new Vertex series modules are designed for utility and large commercial & industrial projects and come in two versions - the bifacial double-glass modules and back sheet modules.

Based on Trina Solar's superior multi-busbar technology, the Vertex modules incorporate an innovative design that integrates half-cut, non-destructive cutting and high-density interconnect technologies. By virtue of low-voltage and higher module string power output, the new Vertex series unlocks huge potential for further reducing balance-of-system costs.

		Maximum Power	# of cells	Size/Weight
Vertex 500W+	DE18M(II)	480-505 W	150 cells (3 x 50)	2176 x 1098 x 35 mm/26.3kg
	DEG18MC.20(II)	480-505 W	150 cells (3 x 50)	2176 x 1098 x 35 mm/30.1kg
Vertex 550W+	DE19	530-555 W	110 cells (2 x 55)	2384 x 1096 x 35 mm/28.6kg
	DE19C.20	530-555 W	110 cells (2 x 55)	2384 x 1096 x 35 mm/32.6kg
Vertex 600W+	DE20	580-605 W	120 cells (2 x 60)	2172 x 1303 x 35 mm/30.9kg
	DEG20C.20	580-605 W	120 cells (2 x 60)	2172 x 1303 x 35 mm/35.3kg

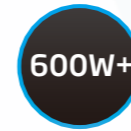

600W+ ultra-high power with 21.4% high efficiency



Low voltage, high string power



12-year product warranty, 30-year power warranty



Monofacial and bifacial options



Better temperature coefficient (-0.34%), lower working temperature result in more generated power



Up to 30% additional power gain from rear side in different installation environments



Excellent IAM (Incident Angle Modifier) and low light performance, validated by 3rd party certifications



Best cell bending strength and performance by adoption of non-destructive cutting technology



High-density interconnection and 12 busbar design

THE DUOMAX SERIES



Designed for harsh environments, such as deserts, saline-alkali and tropical beaches

Trina Solar dual-glass series features high reliability in extreme conditions, an extended 30-year warranty and more power generation with the integration of half-cut, dual glass and multi-busbar technologies. We have gathered rich practical experiences from over 3GW Duomax module installations.

Duomax is the most reliable module with the special feature of zero water penetration. The glass-glass structure isolates most of the natural ageing factors and water vapor from the rear side to eliminate EVA hydrolysis. Moreover, the new generation dual glass module adopts lighter 2+2 mm glasses and outer frames to achieve easier and safer transportation and installation.

DUOMAX

DUOMAX^M

		Maximum Power	# of cells	Size/Weight
Duomax 120	PEG6H.20	285-300 W	120 cells (6 x 10 x 2)	1700 x 1002 x 30 mm / 22 kg
Duomax 144	PEG15H.20	340-355 W	144 cells (6 x 12 x 2)	2024 x 1002 x 30 mm / 26 kg
Duomax M 120	DEG6H.20(II)/ DEG6M.20(II)	320-345 W	120 cells (6 x 10 x 2)	1700 x 1002 x 30 mm / 22 kg
Duomax M 144	DEG15H.20(II)/ DEG15M.20(II)	380-415 W	144 cells (6 x 12 x 2)	2024 x 1002 x 30 mm / 26 kg
Duomax M 144	DEG17M.20(II)	430-450W	144 cells (6 x 12 x 2)	2111 x 1046 x 30 mm / 28.6 kg



Over 3GW cumulative dual glass shipments globally



First in the industry to obtain TUV standard certification and achieve mass production

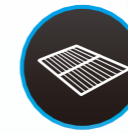

Half-cut and 9 busbar design



2.0+2.0mm glass-glass, lighter and easy to install



Extended 30-year power warranty, <0.5% annual degradation



Symmetric structures minimize micro-cracks and snail trails



Fire class A certified



THE DUOMAX TWIN



Designed for utility projects, especially for highly reflective environments

The Duomax Twin module combines highly efficient bifacial cells with a dual glass structure. It can convert light that strikes both the front face and the rear face of the module into electricity. It also features an extended 30-year performance warranty with lower degradation, resulting in higher guaranteed lifetime power output.



	Maximum Power	# of cells	Size/Weight
DEG6MC.20(II)	315-340 W	120 cells (6 x 10 x 2)	1700 x 1002 x 30 mm / 22 kg
DEG8MC.20(II)	350-370 W	120 cells (6 x 12 x 2)	1773 x 1046 x 30 mm / 25.0 kg
Duomax Twin			
DEG15MC.20(II)	390-410 W	144 cells (6 x 12 x 2)	2024 x 1002 x 30 mm / 26 kg
DEG17MC.20(II)	430-445 W	144 cells (6 x 12 x 2)	2111 x 1046 x 30 mm / 28.6 kg

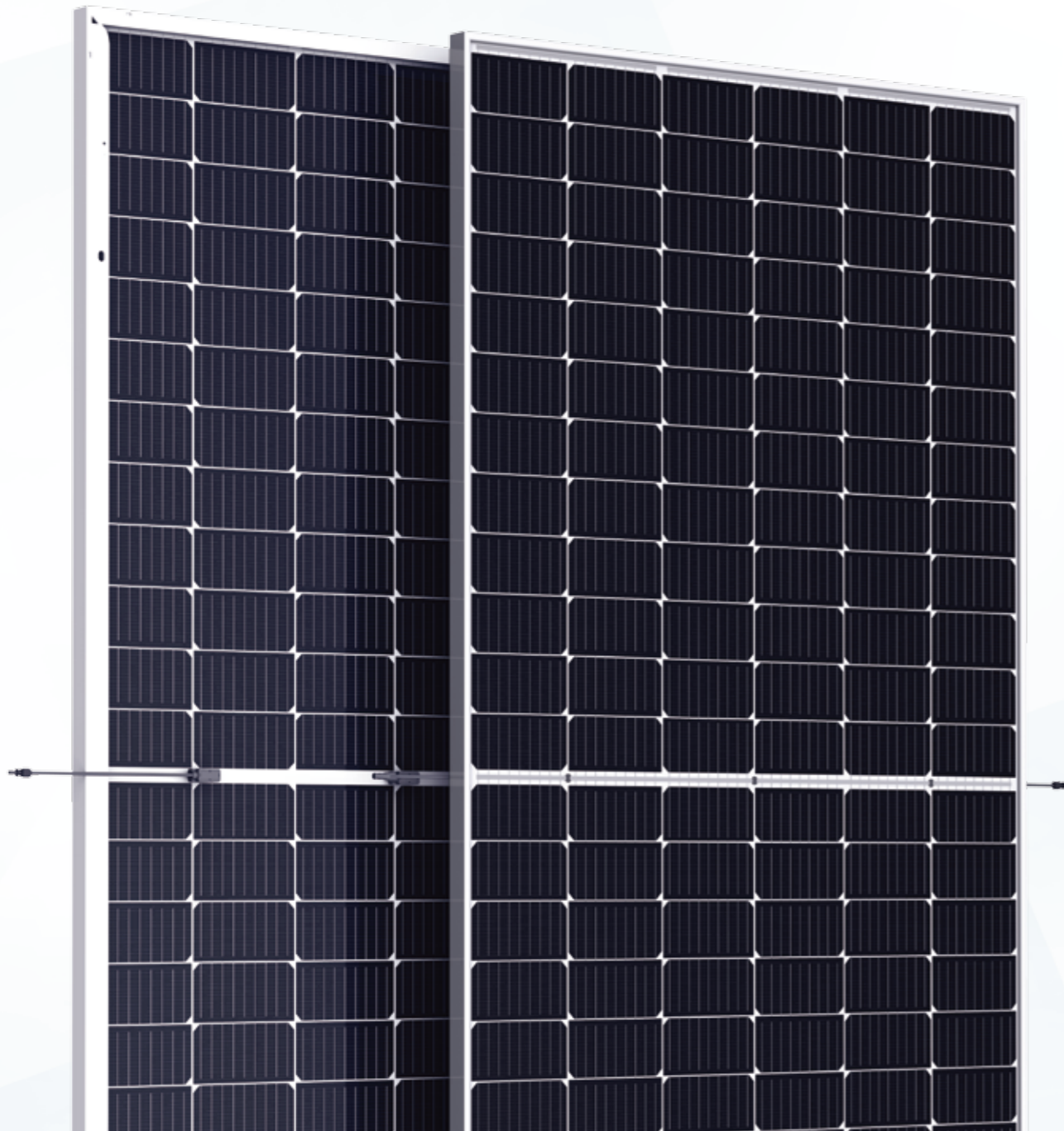

- Over 3GW cumulative dual glass shipments globally
- First in the industry to obtain TUV standard certification and achieve mass production
- 18 dual glass patents
- 2.0+2.0mm glass-glass, lighter and easy to install
- Resistant to environmental erosion from sand, acid, salt mist and alkali
- Best match for trackers
- Less than 1% power degradation in LeTID test by TUV Rheinland
- Over 80% bifaciality, 5%-30% additional power gain from back side
- Extended 30-year power warranty

THE TALLMAX SERIES



The Tallmax module is designed for commercial and utility-scale solar projects to achieve significant system savings. Tallmax modules are recognized by industry professionals for their proven performance in the field.

By integrating innovative technologies like half-cut cells and multi busbars, the maximum output of the 144-cell Tallmax module can reach 415W. The increase in output from 370W to 415W will help reduce the balance of system (BOS) cost by 4.5% to 8.5%, and reduce levelized cost of electricity (LCoE) by up to 4.6%.

		Maximum Power	# of cells	Size/Weight
Tallmax	PE15H/PE15M	340-360 W	144 cells (6 x 12 x 2)	2015 x 996 x 35 mm / 22 kg
Tallmax M	DE15H(II)/DE15M(II)	380-415 W	144 cells (6 x 12 x 2)	2015 x 996 x 35 mm / 22 kg
Tallmax M	DE17M(II)	430-450 W	144 cells (6 x 12 x 2)	2102x 1040 x 35 mm / 24.0 kg



Half-cut and 9 busbar design

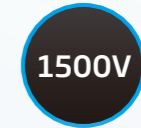

Fully certified for 1500V system



Widely used in over 100 countries



35mm frame, front/back side maximum static load: 5400Pa/2400Pa



High reliability with best manufacturing techniques



Different BOM for different climates to ensure power generation for its entire lifetime

THE HONEY SERIES



Designed for residential and commercial installation

The Honey series with 120 half-cut cells can generate maximum energy yield even in limited space. As one of the industry's most trusted modules, the Honey series is the most sought after option for residential and commercial customers because of its reliability, pleasing aesthetics and compatibility with all major balance of system components and module electronics.

HoneyBlack M, as the premium option of the Honey series, is equipped with a multi-busbar black cells, black backsheet and matte black frame making it the perfect aesthetic choice for high-end residential rooftops.

		Maximum Power	# of cells	Size/Weight
Honey	PE06H	285-300 W	120 cells (6 x 10 x 2)	1690 x 996 x 35 mm / 18 kg
Honey M	DE06H(II)/DE06M.08(II)	320-340 W	120 cells (6 x 10 x 2)	1690 x 996 x 35 mm / 18 kg
Honey M	DE08M.08(II)	355-375 W	120 cells (6 x 10 x 2)	1760 x 1040 x 35 mm / 20.0 kg
HoneyBlack M	DD06M.05(II)	315-335 W	120 cells (6 x 10 x 2)	1690 x 996 x 35 mm / 18 kg



Half-cut and 9 busbar design



High reliability with best manufacturing techniques



1st year degradation $\leq 2.5\%$



Different BOM for different climates to ensure power generation throughout its lifetime



35mm frame, front/back side maximum static load: 5400Pa/2400Pa



Ensured PID resistance through cell process and module material optimization



Matte black frame



Black frame adhesive



Black label



String connectors covered in black



Black cells with multi-busbar technology

PROJECT REFERENCES



Miyazaki City, Miyazaki Prefecture, Japan 96.2MW / Tallmax / 2018



Hidaka Gun, Hokkaido Prefecture, Japan 21MW / Honey / 2018



Golmud, Qinghai, China 20MW / Duomax / 2018



Ha Tin, Vietnam 50.067MW / Tallmax / 2019



Clare, Australia 129MW / Duomax / 2018

PROJECT REFERENCES



Kasaoka City, Okayama Prefecture, Japan
2.64MW / Duomax / 2018



Huaibei, Anhui, China
40MW / Duomax / 2018



Golmud, Qinghai, China
20MW / Duomax Twin / 2018



Gotemba city, Shizuoka prefecture, Japan
4.4MW / Tallmax / 2018



Baise, Guangxi, China
18MW / Tallmax & Honey / 2017



Tami Nadu, India
30MW / Tallmax / 2017

GLOBAL CONTACTS

CHINA

400 988 0000 (Chinese mainland only)

+86 519 8517 6109 (Overseas only)

Changzhou
Corporate Headquarters
No.2 Tianhe Road, Trina PV Industrial Park,
Xinei District, Jiangsu, China
F +86 519 8517 6021
E Chies_china@trinasolar.com

Shanghai
Room 1705-1706, Building-B,
Zhongjin International Square,
Caoxi North Rd 333, Shanghai
F +86 21 6057 5333
E sales_china@trinasolar.com

Beijing
Level 18 Minsheng Square, No.38 Dongsanhuan
Road, Chaoyang District, Beijing
T +86 10 5207 4500
F +86 10 5651 8320
E sales_china@trinasolar.com

JAPAN

Japan
Trina Solar (Japan) Limited
21F World Trade Center Building
2-4-1 Hamamatsu-cho,
Minato-ku, Tokyo 106-6121
T +81 3 3437 7000
F +81 3 3437 7001
E japan@trinasolar.com

ASIA PACIFIC

Singapore
Regional Headquarters
Trina Solar (Singapore) Pte Ltd
600 North Bridge Road,
#12-01 Parkview Square,
Singapore 188778
T +65 6808 1111
F +65 6822 1565
E apac@trinasolar.com

India
Trina Solar (India) Regional
Sales Office
Unit No- 824, 8th Floor,
DLF Tower- B, Jasola District Center,
New Delhi -110025, India
T +91 11 4585 2200
F +91 11 4585 2207
E salesindia@trinasolar.com

Australia
Trina Solar (Australia) Pty Ltd
Suite 44.05, Level 44,
Governor Phillip Tower,
1 Farrer Place
Sydney NSW 2000
T +61 1300 874 627
E australia.sales@trinasolar.com

EUROPE

Switzerland
Regional Headquarters
Trina Solar (Schweiz) AG
Birkenweg 4
8304 Wallisellen
T +41 43 299 6800
F +41 43 299 6810
E europe@trinasolar.com

Germany
Trina Solar (Germany) GmbH
Werner-Eckert-Str. 4,
81829 München
T +49 89 122 8492 50
F +49 89 122 8492 51
E germany@trinasolar.com

Spain
Trina Solar (Spain) S.L.U.
C/Caleruega, 79 - 3A
28033 Madrid
T +34 911 335 935
F +34 911 724 536
E spain@trinasolar.com

Italy
Trina Solar (Italy) S.r.l.
Via Santa Maria Valle 3,
20123 Milan
T +39 02 0068 1230
F +39 02 0066 1420
E italy@trinasolar.com

France
Trina Solar (France)
Regional Sales Office
E france@trinasolar.com

Turkey
Trina Solar (Turkey)
Regional Sales Office
E turkey@trinasolar.com

Luxembourg
Trina Solar (Luxembourg) S.à.r.l.
26-28, rue Edward Streichen
L-2450 Luxembourg
T: +352 27 112 7047
F: +352 27 112 7200

United Kingdom
Trina Solar (UK) Ltd Pegasus Business Park
Herald Way, Castle Donington
Derby, DE74 2TZ
T +44 1332 638 700
F +44 1332 638 160
E uk@trinasolar.com

NORTH AMERICA

United States
Regional Headquarters
Trina Solar (U.S.) Inc
100 Century Center, Suite 501
San Jose CA 95112
T +1 800 696 7114
F +1 800 696 0166
E usa@trinasolar.com

Canada
T +1 800 696 7114
E canada@trinasolar.com

LATIN AMERICA AND THE CARIBBEAN

Latin America
Trina Solar Latam Services 11900 Biscayne.
Suite #602 Miami FL, 33181
T +1 (305) 603 7878
E latam@trinasolar.com

Chile
Trina Solar (Chile) SPA
Av. Nueva Tajamar 555, oficina 1501,
Las Condes, Santiago - Chile.
T +56 2 2594 7586
E latam@trinasolar.com

México
Trina Solar México S.A de C.V
Av. Presidente Masaryk 61, piso 10,
oficina 1002, Col. Polanco V Sección C.P.
11560 Del. Miguel Hidalgo,
CDMX, México
T +52 (55) 5204 7566
T +52 (55) 7155 4831
E latam@trinasolar.com

Brazil:
Trina Solar (Brasil) Representação e
Marketing Ltda
Edifício Pilar R. Tenerife, 67,
conjunto 41- Vila Olímpia,
São Paulo - SP, 04548-040
E latam@trinasolar.com

MIDDLE EAST & AFRICA

United Arab Emirates
OneJLT, 6th Floor, Dubai, UAE
T: +971 4 429 5872
E MiddleEast_Africa@trinasolar.com